

# HELIOSTAR® 252, 218 VERTICAL, FREE INSTALLATION

INSTRUCTION MANUAL

**Roth**

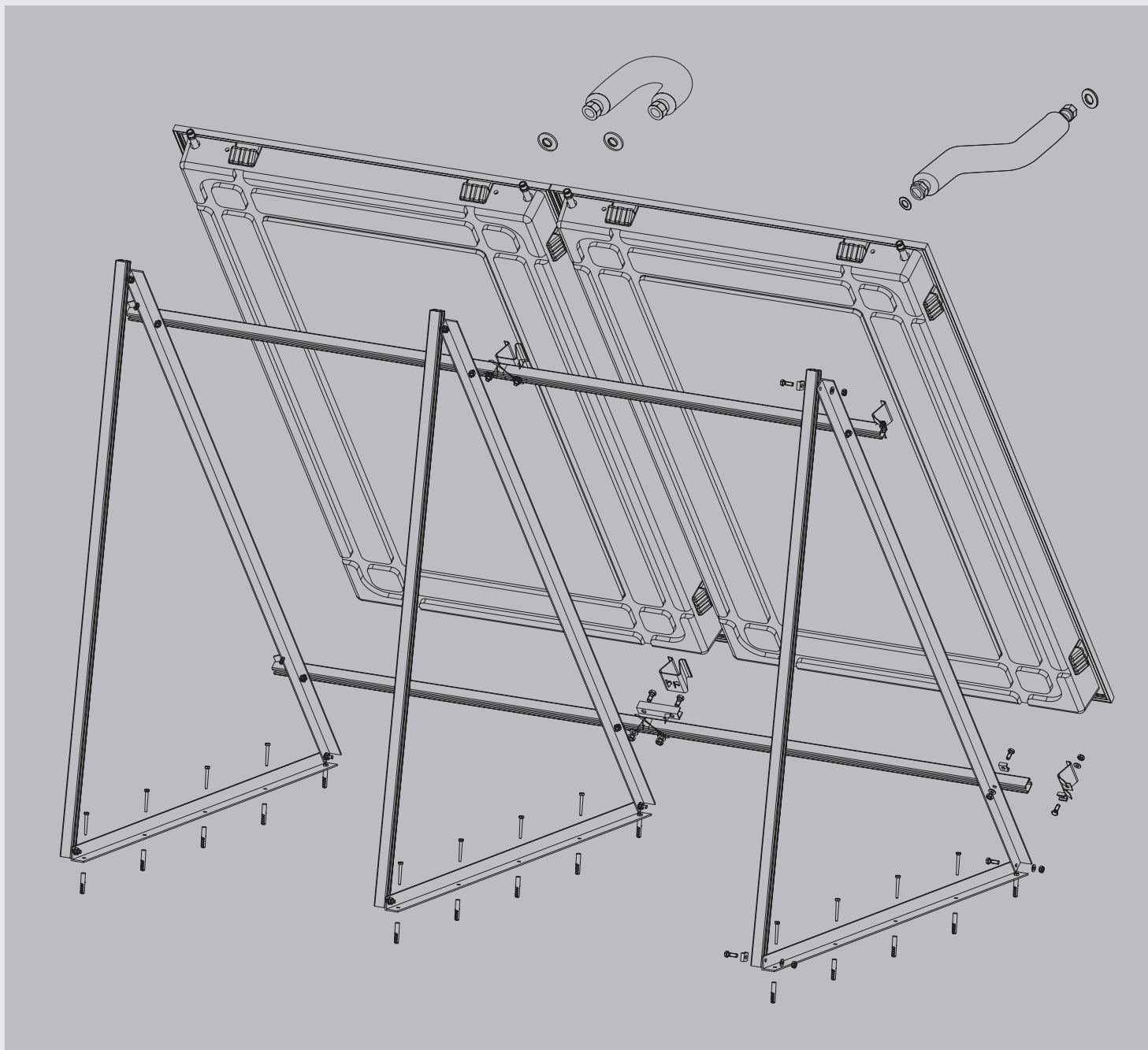

**ENERGY AND SANITARY SYSTEMS**

# Installation requirements

## ■ General requirements

The free-standing installation set is to be used or installing Roth Heliostar® 252 and 218 flat collectors outdoors, on flat roofs and/or on flat inclined roofs.

## ■ Safety information

**Read these installation instructions carefully before beginning installation and comply with the safety instructions contained therein.** Applicable **industrial safety regulations** and the rules of technology are to be observed, particularly when working on roofs. Because of statics considerations, please contact the Roth hotline for situations subject to snow pressures of Zone 4 and above and for installation sites that exceed 600 m above sea level.

**Important:** It is possible that the collectors cannot be completely emptied with this installation version. Consequently, the solar installation may not be filled with anything other than

water/antifreeze mixtures, which means that it is absolutely necessary to top up with antifreeze, including after pressure or function tests!

**Important:** When storing the collectors prior to installation, make sure that they are neither left outdoors nor stored lying on their glass surfaces and/or uncovered, because otherwise moisture could make its way into the ventilation holes located in the frame. When installing the collector connections, make sure that they are annealed. For that reason, always press hard when tightening the 1/2" thread connection! Non-compliance with this instruction could lead to damage to the collector!

## ■ Static requirements

The person who erects the unit is solely responsible for sufficient anchoring of the collectors outdoors or on roofs, particularly where there are strong winds. The weight specifications contained in the present installation instructions for weighing the unit down are to be expressly understood as not covered by any guarantee on the part of the manufacturer!

Roth assumes no liability whatsoever in cases of damage. The warranty in accordance with the conditions of guarantee that apply to the material supplied by Roth remains unaffected by this. The pertinent standards and guidelines apply, in particular DIN 1055-T4 in terms of minimum weight loads with various building heights.

## ■ Potential adjustment and lightning protection

The metallic pipelines of the solar circuit are to be connected with the main potential equalisation rail by means of a green/yellow wire of a minimum of 16 mm<sup>2</sup> Cu (H07 V or R). If a lightning protection installation is present, then the collectors can also be linked to it. Earthing can also otherwise take

place by means of a ground rod. The earth cable is to be laid outdoors against the house. The earthing bar is also to be connected with the main potential equalisation rail through the use of a wire with the same cross-section.

## ■ Installation of sensor

The sensor is to be mounted in the last flooded collector on the side of the leader (hot outlet). The rubber sleeve is to be removed for this purpose, the sensor is to be threaded through and the rock wool in the interior of the collector is to be pushed a little to the side. Then apply some heat conducting paste to the sensor and insert it as far as possible into the immersion sleeve. To complete the process, push the rubber sleeve back in until

the counter lip engages with the collector frame. A cable with a cross-section of 2 x 0.75 mm<sup>2</sup> is sufficient for extending the sensor cable up to 50 m, beyond which a cross-section of 2 x 1.5 mm<sup>2</sup> is to be used. It is expedient to protect the connected control unit and the sensor against overvoltage by lengthening the collector sensor to include an overvoltage protection casing (optional) immediately after the collector.

## ■ Overview of tools

For installing you need the following tools:

- Electric drill with 12 mm rock drill bit
- Open-ended spanner 17 / 19
- Pipe wrench
- Folding ruler

# Materials list

Pos.	Material-No.	Description	Quantity
1	1125005701	C-profile 36 x 30 x 1900 mm F3	2
2	1150002871	SKT-screw M10 x 30 DIN 933 galvanised	8
3	1150002874	SKT-screw M10 x 60 DIN 933 galvanised	6
4	1150002840	SKT-nut M10 DIN 985 (EN ISO 10511) galvanised	10
5	1150002840	SKT-nut M10 DIN 934 galvanised	4
6	1150006885	U-washer 10,5 mm DIN 125 galvanised	14
7	1150006896	U-profile 25 x 10 x 25 mm Alu	14
8	1150002928	SKT-wood screw 8 x 60 DIN 571 galvanised	8
9	1150007862	Plug S12 x 60	8
10	1125005411	Installation rail vertical L: 1205 mm	4
11	1150007739	Attachment clamp single	4
12	1150007946	Installation instruction free installation Heliostar®	1
13	1150006895	T-piece 60 x 60 x 6 mm l: 40 mm	4
14	1155000551	Packing	1

■ Attachment free installation vertical basic set H

Pos.	Material-No.	Description	Quantity
1	1125005701	C-profile 36 x 30 x 1900 mm F3	1
2	1150002871	SKT-screw M10 x 30 DIN 933 galvanised	2
3	1150002874	SKT-screw M10 x 60 DIN 933 galvanised	3
4	1150002840	SKT-nut M10 DIN 985 (EN ISO 10511) galvanised	5
5	1150006885	U-washer 10,5 mm DIN 125 galvanised	5
6	1150006896	U-profile 25 x 10 x 25 mm Alu	5
7	1150006884	SKT-screw M12 x 20 DIN 933 galvanised	4
8	1150002841	SKT-nut M12 DIN 934 galvanised	4
9	1150006886	U-washer 13 mm DIN125 galvanised	4
10	1150002928	SKT- wood screw 8 x 60 DIN 571 galvanised	4
11	1150007862	Plug S12 x 60	4
12	1125005411	Installation rail vertical L: 1205 mm	3
13	1125005192	U-connection profile 25 x 25 x 3 mm l: 130 mm Al	2
14	1150007740	Attachment clamp double 2-fach	2
15	1150006892	Stainless steel corrugated hose L: 300 mm 1/2"	1
16	1150007946	Installation instruction free installation Heliostar®	1
17	1150006895	T-piece 60 x 60 x 6 mm l: 40 mm	2
18	1155000551	Packing	1

■ Attachment free installation vertical extension set H

# Installation instructions

## Ground anchoring

System variants:

- With concrete pedestal

### Minimum weight load in accordance with DIN 1055-4:

Up to 8 m building height 75 kg/m<sup>2</sup> collector surface.

Up to 20 m building height 127 kg/m<sup>2</sup> collector surface.

Distance to the edge of the roof at least 2 m.

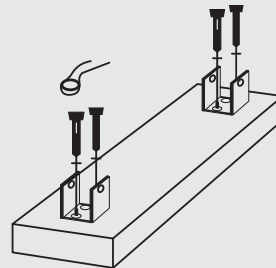

## ■ Installation steps

1. M10 x 60er screw to be fixed with U-profile in the installation rail.



2. Attach with washer and nut to vertical installation rail. (Insert until end of long whole)



3. **Important:** vertical installation rail must be inserted until it creates one level (see red line in the picture).

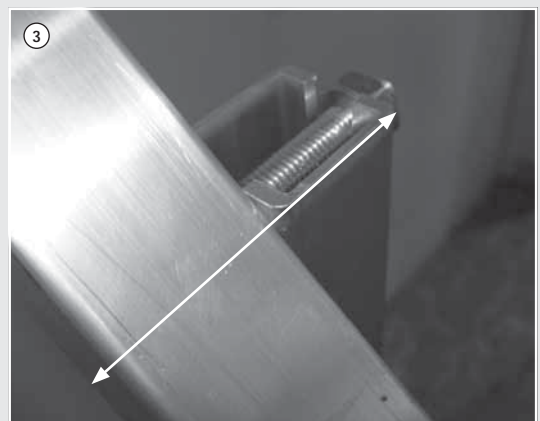

# Installation instructions

## ■ Installation steps



4. Now we created a triangle for the side. The delivered T-pieces will be installed as shown below.



5. M10 x 30 screw to be inserted in the U-profile and through the boring above in the T-piece. It is softly fixed with washer and nut.



6. The prepared connection is inserted in the installation rail and afterwards fixed. This procedure is carried out on the lower end of the vertical and slope rail.

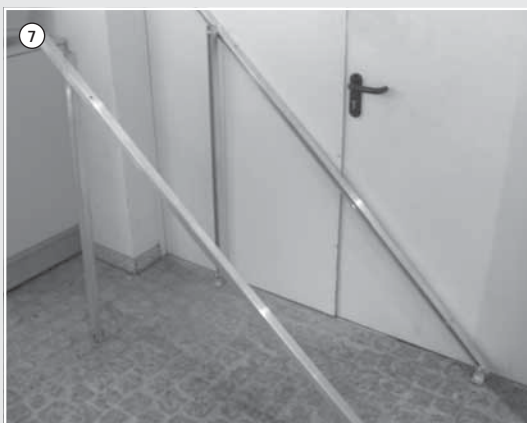

7. This procedure is carried out for the installation of the second triangle.

# Installation instructions

## ■ Installation steps

8. The installation of both horizontal rails (above and below) is carried out as follows:

**Important:** For the installation of horizontal rails you will find pre-installed holes. In the upper area of the shown installation rails there are 2 holes, the upper holes are to position the horizontal rail for the installation of the **Heliostar® 252**, the holes below are for the installation of the **Heliostar® 218**.



9. The horizontal rails are inserted with M10 x 60 screws in the U-profile and completely pushed in the installation rail.



10. The distance of the outer edge slope rail compared to outer edge horizontal rail should be 75 mm.

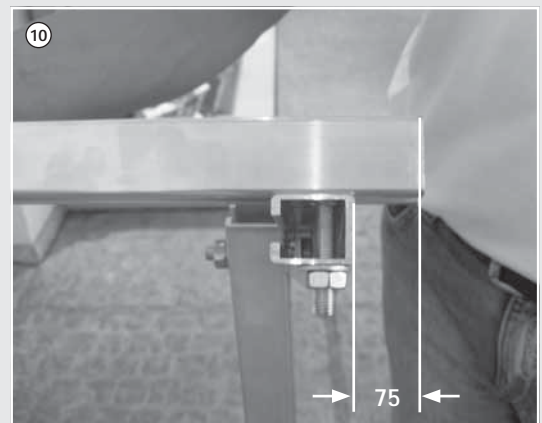

11. After the upper horizontal rail is fixed, the rail below will be mounted the same way.



# Installation instructions

## ■ Installation steps



12. Finished installation of the below horizontal rail.

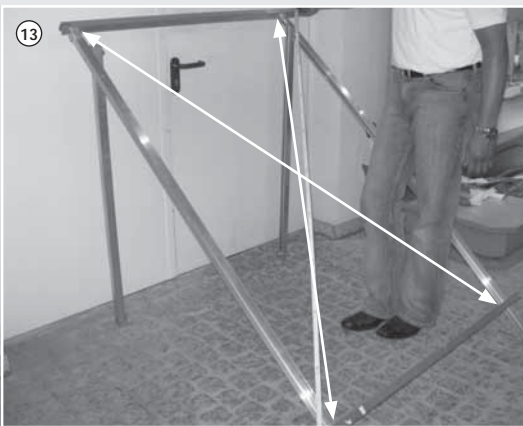

13. To be sure that both horizontal rails have the same distance you have to find out the diagonal distance.



14. After finishing of the holding rack, you have to fix it on the bottom. For doing that, you have to mark on each T-piece two boreholes. You have to move the rack aside and the boreholes have to be made by a 12 mm rock drill. Following the 12 mm plugs have to be inserted in the holes, the rack has to be posed on the boreholes and it has to be fixed on the bottom with the 8 x 60 mm wood-screws.



15. If the rack is fixed on the bottom, the solar-panel Heliostar® has to be applied on the rack.

# Installation instructions

## ■ Installation steps

16. The solar-panel will be fixed by lateral attachment clamps on the rack (4 lateral attachment clamps for the first solar-panel).

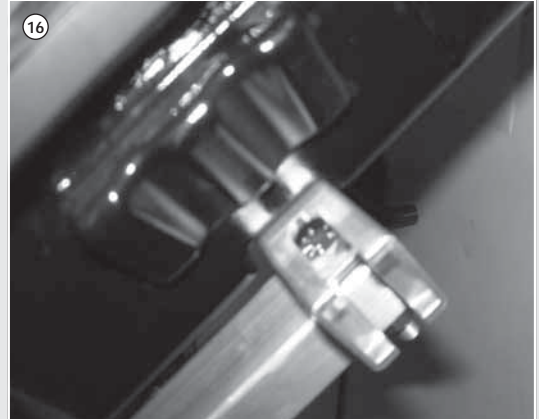

17. The lateral attachment clamps have to be fixed by M10 x 30 screw, u-washer and nut in the lateral long hole of the horizontal rail.

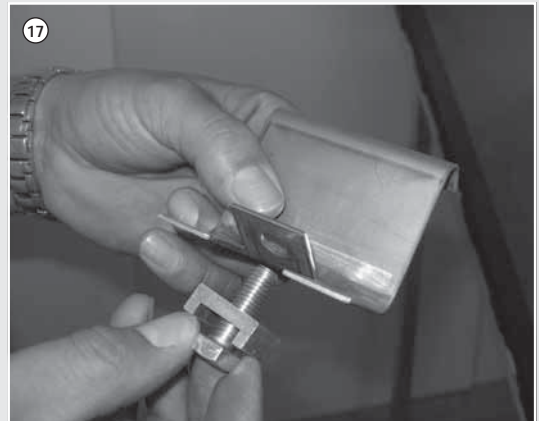

18. Finished lateral rack.



All explained steps up to now are useful for the fixing of one solar-panel Heliostar® in vertical position by using the Roth Basic Set. If you want to install more than one solar-panel Heliostar® in line, you have to substitute on one side of the rack the lateral attachment clamps by the double attachment clamps. You'll find these double attachment clamps in the Roth Extension Set. Below you find the procedure for the installation of the extension set.



# Installation instructions

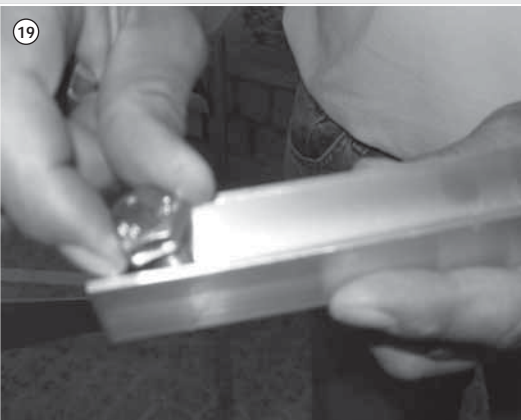

19. Both M12 x 20 screws have to be inserted in the connection rails for the upper and below horizontal rail as shown on the photo.

## ■ Installation steps



20. On the opposite side the u-washer and nut have to be inserted and have to be tightened easily by hand.



21. The connection rails have to be inserted on half into the rail and have to be tightened.

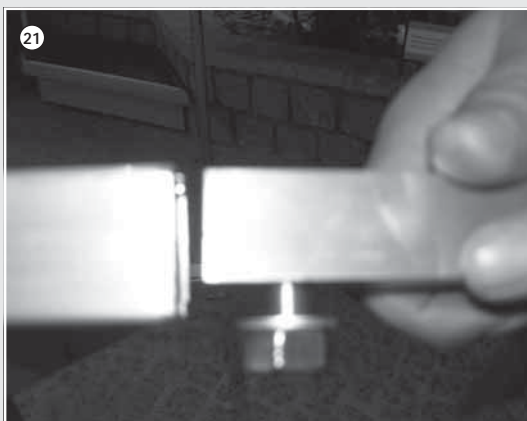

# Installation instructions

## ■ Installation steps

22. The attachment cramp double has to be attached on the upper and below rail.



23. Depending on the number of solar-panels Heliostar® to install, you have to assemble the next triangle as explained at the beginning.



24. The upper and below horizontal rail has to be attached and to be fixed.



25. The repetition of this procedure depends on the number of solar-panels Heliostar®.



# Installation instructions

## ■ Installation steps



26. The first and the last solar-panel Heliostar® has to be fixed with the attachment clamp sideways.



27. Remove the cable lead at the return of the collector field and slide it over the cable of the temperature sensor: temperature insert sensor into the immersion sleeve as far as possible and remount the cable lead in the collector.



28. The collectors are connected with one another by means of the short corrugated tube. Gasket rings and insulation are included. No ventilation of the corrugated tube is not required at this point.

# Installation instructions

## ■ Industrial safety instructions and regulations of technology

- Installation on roofs: DIN 18338 tilers and roof sealing work, DIN 18339 plumbing, DIN 18451 scaffold work
- Connection of thermal solar installations: DIN 4757 part 1 and 3
- Electrical connections: VDE 0100 installation of electronic equipment, VDE 0185 general information with regard to lightning protection installation, VDE 0190 main potential adjustment of electronic installations, DIN 18382 electronic cables in houses

Detailed information referring to prevention of accidents can be found at Accident Prevention and Insurance Association.

## ■ Frutiger Bold, 9 pt.

## ■ Frutiger Bold, 9 pt.

## ■ Frutiger Bold, 9 pt.

### Use ladder appropriate

Use ladder only for a height difference up to 5 m. Lean and secure in an angle of 65-75°. Exit must be topped by a minimum of 1 m.

### Security of not falling of the roof

In case of falling height > 3m on roofs with a slope between 20° and 60°, it is required to provide corresponding security for falling protection (VBG 37, § 8). The vertical distance from the working place to the roof scaffold or alternatively the roof protection wall should not exceed 5 m. For protection it is also possible to use a safety line. Security hooks must be installed above the user on a sustainable component. Do not use ladder hooks.

### Security of falling parts

Protect roads and working places below against falling or upsetting components. These areas must be marked and blocked.

Information can also be obtained from the Roth hotline: Tel. +49 (0) 64 66/9 22-266

# Roth

ROTH WERKE GMBH  
Am Seerain 2 • 35232 Dautphetal  
Telefon +49 (0) 64 66/9 22-0 • Telefax +49 (0) 64 66/9 22-1 00  
Hotline +49 (0) 64 66/9 22-2 66  
E-Mail [service@roth-werke.de](mailto:service@roth-werke.de) • [www.roth-werke.de](http://www.roth-werke.de)

