

# ON-ROOF ATTACHMENT FLAT COLLECTOR HELIOSTAR® INSTALLATION INSTRUCTIONS

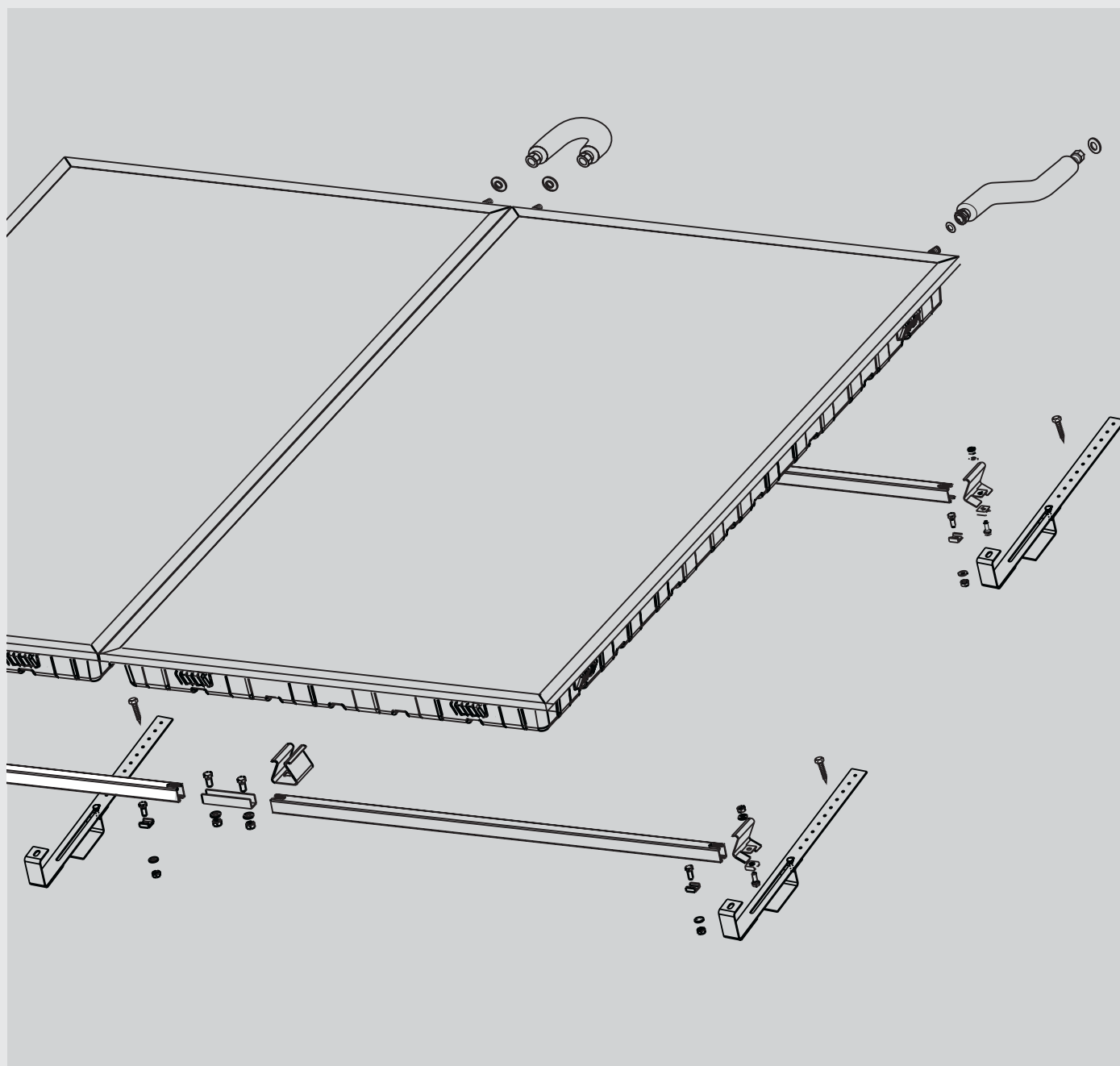

# Installation requirements

## ■ General requirements

The on-roof attachment set is capable for installation of Roth flat collectors Heliostar® on roofs with a slope greater than 22°. One attachment anchor universal can be used for roofs with covering made of pantiles/ roofing tiles and similar roofing stones as well as plain tiles and fibre-cement corrugated plates. Installations on roofs made of natural slates should be carried out by companies employing professional tilers only.

**Please note:** You may need additional material such as ventilation roofing tiles for the roof lead-through of the collector field connections (available in special tiler stores and construction material wholesalers), possibly adjustment lumbers for padding the rafter anchor, sheet metal for sealing the rafter anchor when using plain tiles. To carry the collector on the roof additional equipment could be required.

## ■ Safety information

**Please read the installation instructions before starting the installation carefully and follow the indicated safety information.** The valid industrial **safety instructions** and regulations of technology especially with regard to working on the roof have to be observed (see page 12). In case of higher loads of snow starting from zone 4 and in places above 600 m NN, please contact our technical department to discuss statics of the installation.

**Important:** When storing the collectors before installation, make sure the collectors do not stand outside, lay on the glass and/or are stocked uncovered, to avoid humidity entering into the collector through the wholes in the collector frame. Before installing the collector connections, they must be annealed. Therefore, always push strongly against the 1/2" thread connection when tightening. Non-compliance can result in damage of the collector.

## ■ Potential adjustment and lightning protection

The metal pipelines of the solar circuit must be connected through a green/yellow conductor of min. 16 mm<sup>2</sup> Cu (H07 V respectively R) with the main potential adjustment rail. If a lightning protection installation is available, the collectors can be linked to it. Earthing can

also be done by a depth earth electrode. The grounding cable must be placed outside on the house. In addition the earth electrode must be connected with the main potential adjustment rail with a cable of the same diameter.

## ■ Installation of sensor

The sensor must be installed in the last flooded collector on the supply side (hot outlet). For this purpose, the rubber sleeve must be removed, the sensor must be threaded and the rock wool inside of the collector should be pushed aside. Afterwards place some heat conducting paste on top of the sensor and insert it as far as possible into the immersion sleeve. In the end push the rubber sleeve back into its position until the countering lip inter-

locks with the collector frame. To extend the cable of the sensor up to 50 m it is sufficient to choose a cable diameter of 2 x 0,75 mm, for more than 50 m a diameter of 2 x 1,5 mm must be used. To protect the connected regulation units against overvoltage the collector sensor is to be extended appropriately, directly behind the collector, through an overvoltage protection case (optional).

## ■ Overview of tools

- Spanner 13/17/19/20/22
- Boring machine,
- Cross slot PZ 3
- Angle grinder with stone shim
- Hammer
- String (approx. 10 m), measuring tape, rope
- Pencil

# System varieties

## Collector surface area: 2,18 m<sup>2</sup> (small version)

### ■ Vertical installation

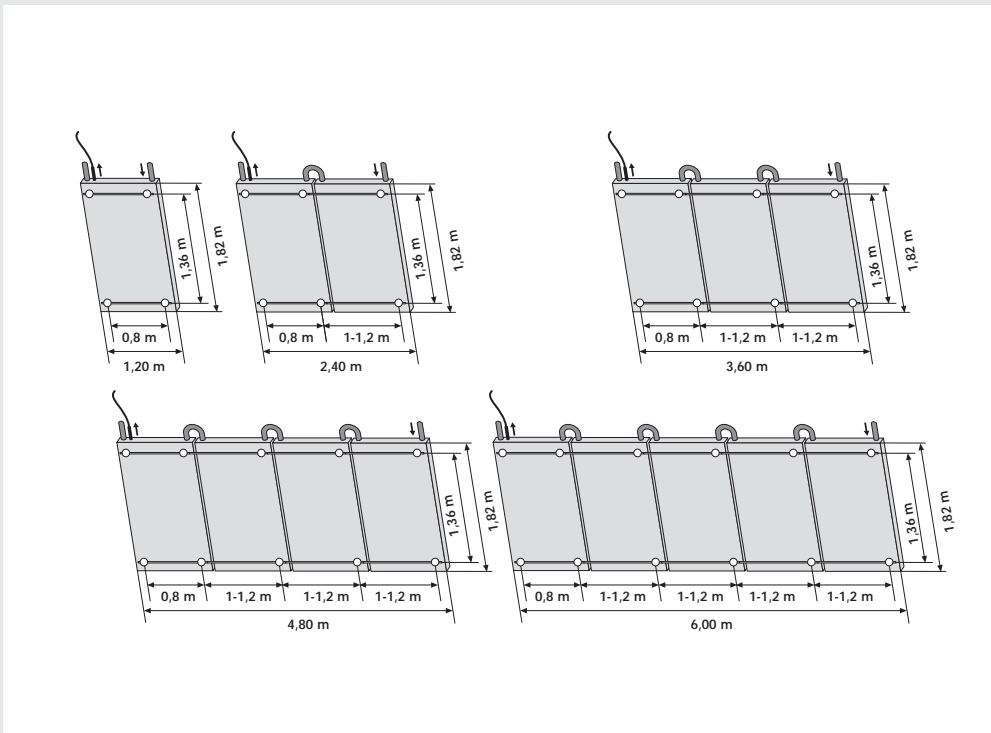

### ■ Horizontal installation

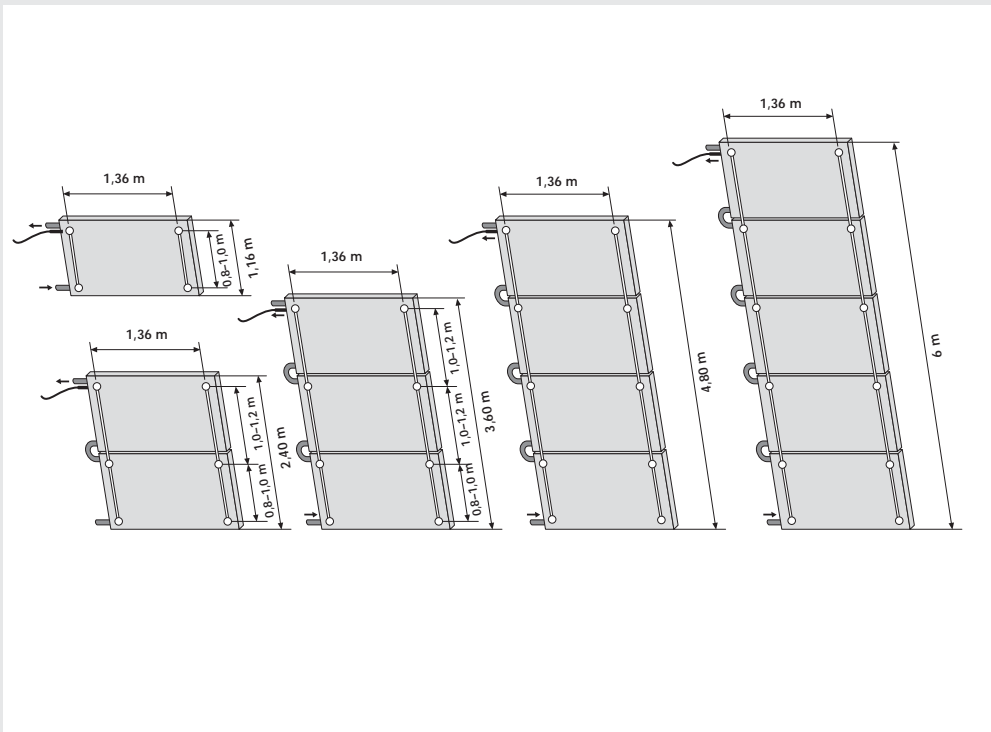

# System varieties

## Collector surface area: 2,52 m<sup>2</sup> (large version)

### Vertical installation

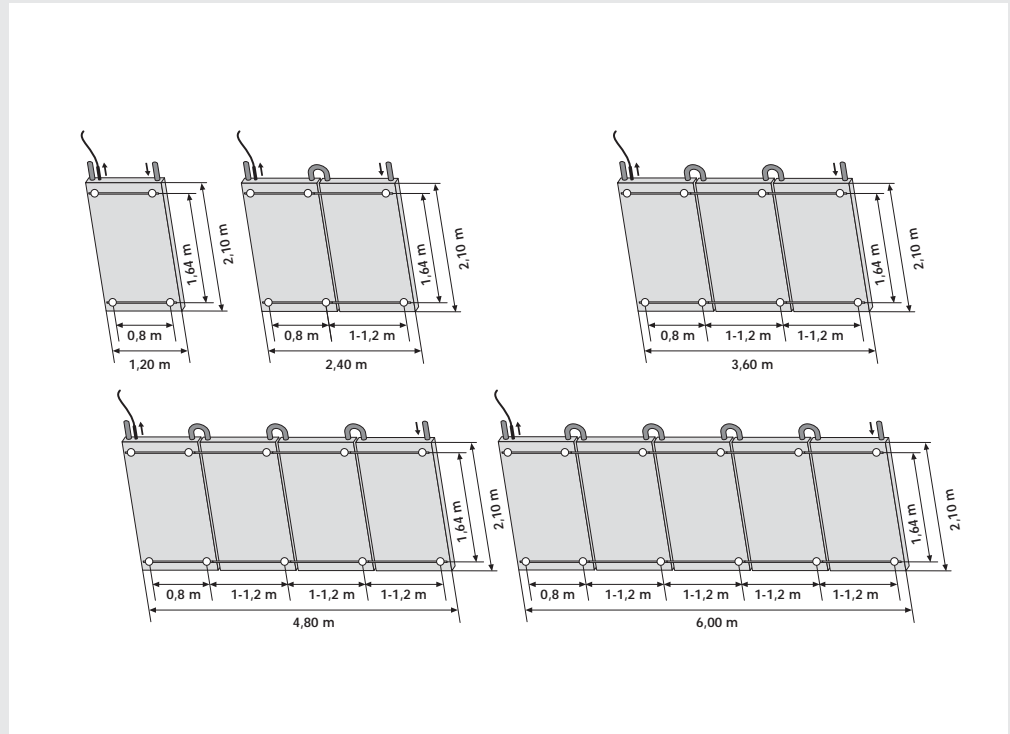

### Horizontal installation

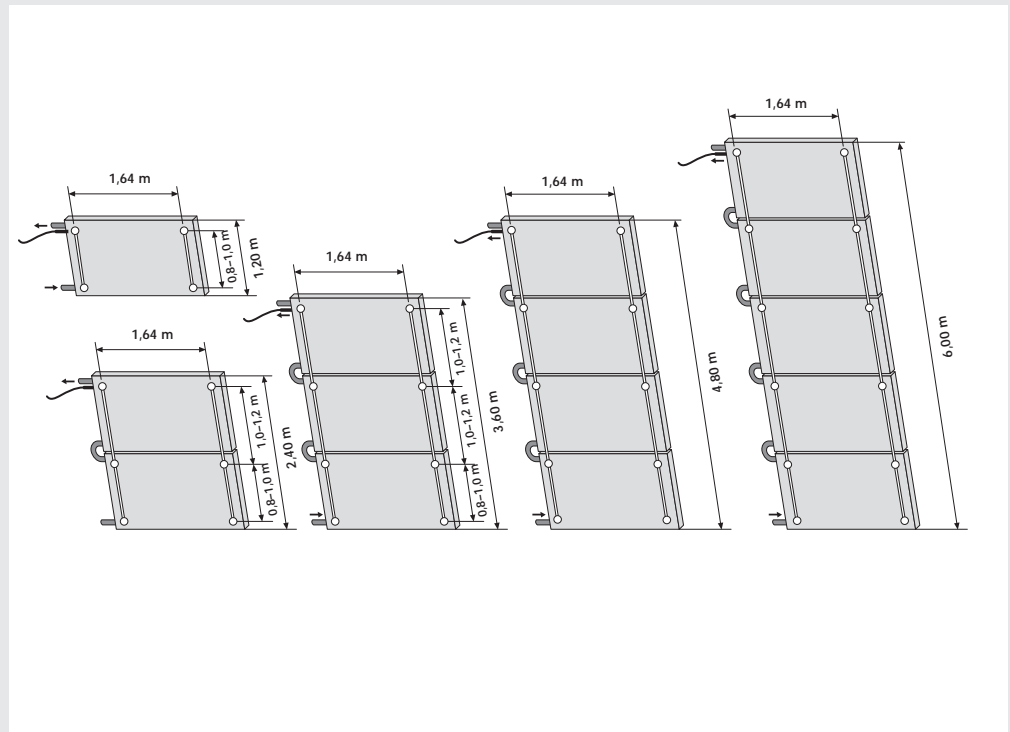

# Overview of material

## Vertical installation

### ■ System components

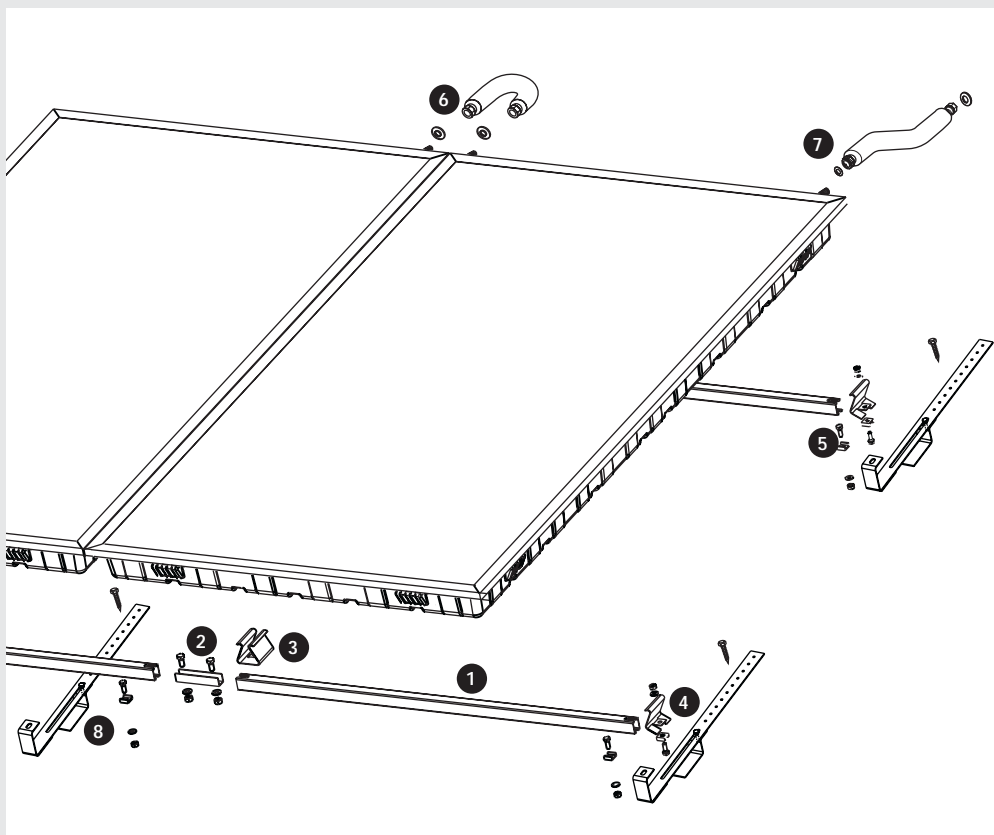

Basic set on-roof installation for vertical alignment flat collector Heliostar®

Material	Basic set for 2 collectors (quantity)	Extension set for each additional collector (quantity)
① Installation rail made of aluminium, length 1205 mm	4	2
② Profile rail connection set (2 connection profiles, 4 hexagonal screws M 12 x 20 with nut and spring washer)	1	1
③ Attachment element D (attachment clamp double)	2	2
④ Attachment element E (attachment clamp single, 4 U profiles, 4 hexagonal screws M 12 x 20 with nut and spring washer)	1	-
⑤ Hexagonal screws made of stainless steel M 10 x 30, U profile discs with washer and nut	6	2
⑥ Stainless steel corrugated hose with union nut 1/2", insulation 20 x 13 mm and sealing ring, L 300 mm	1	1
⑦ Stainless steel corrugated hose with insulation 20 x 13 and sealing rings, length 900 mm	2	-
<b>Accessory</b>		
⑧ Roth attachment anchor universal vertical, incl. attachment screws	6	2

# Overview of material

## Horizontal installation

### ■ System components

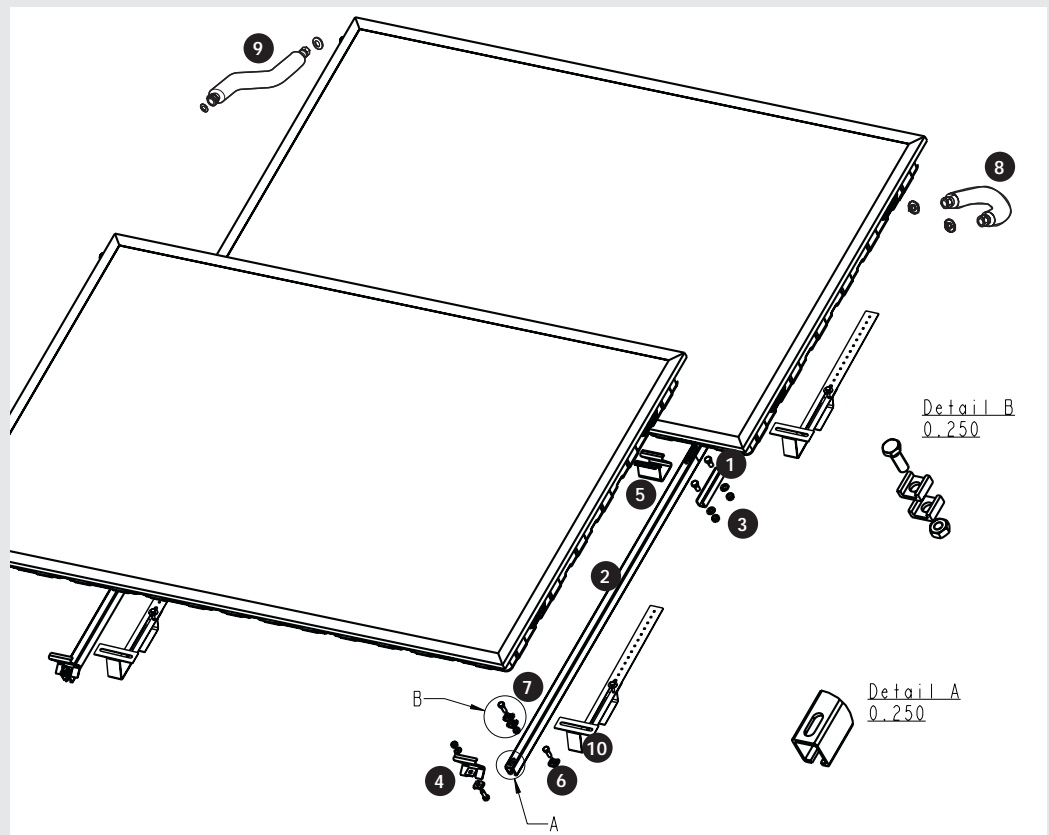

Basic set on-roof installation for vertical alignment flat collector Heliostar®

Material	Basic set for 2 collectors (quantity)	Extension set for each additional collector (quantity)
① Installation rail made of aluminium, length 1205 mm	2	2
② Installation rail made of aluminium, length 1205 mm	2	-
③ Profile rail connection set (2 connection profiles, 4 hexagonal screws M 12 x 20 with nut and spring washer)	1	1
④ Attachment element E (attachment clamp single, 4 U profiles, 4 hexagonal screws M 12 x 20 with nut and spring washer)	1	-
⑤ Attachment element D (attachment clamp double)	2	2
⑥ Hexagonal screws made of stainless steel M 10 x 30, U profile discs with washer and nut	6	2
⑦ Installation rail extension made of aluminium, length 900 mm	2	-
⑧ Stainless steel corrugated hose with union nut 1/2", insulation 20 x 13 mm and sealing ring, L 300 mm	1	1
⑨ Stainless steel corrugated hose with insulation 20 x 13 and sealing rings, length 900 mm	2	-
<b>Accessory</b>		
⑩ Roth attachment anchor universal horizontal, incl. attachment screws	6	2

# Installation instructions

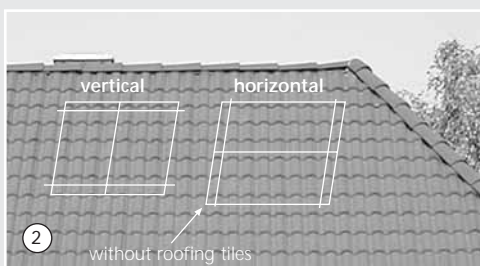
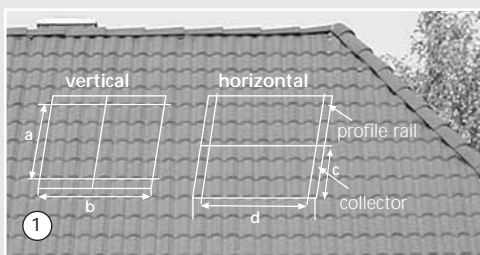

1. Definition of position of the collector field and corresponding attachment anchor universal

For vertical installation:

Measure a: 1,36 m\* (small version)  
1,64 m\* (large version)

Measure b: depends on the size of the rafter distance and the quantity of attachment anchor universal

For horizontal installation:

Measure d: depends on the quantity of attachment anchor universal and the collector field height

Measure c: 0,74 m\*, (both versions).

\* Measure valid for 1 collector field only

2. Removal of roofing tiles to install the attachment anchor universal (per attachment anchor universal 2-3 roofing tiles).

3. Attachment anchor universal

4. **For your safety:** When working in danger of falling off the roof be sure to wear protective equipment (see page 12).

## ■ Roof positioning

## ■ Roof connection

## ■ Safety information

# Installation instructions

## ■ Steps of installation



1. Fix attachment anchor universal with 3 screws 6 x 80 to roof lath. Attachment anchor universal must be positioned in the deep part of the tile.

**Important:** The attachment anchor universal may not impose pressure upon the roof tiles.



2. Pre-assembly profile rails on ground. The screws for the connection of profile rails and attachment anchor universal must be inserted before joining the individual profile segments. For this purpose measure the position of the attachment anchor universal and mark on the profile rails. At this spot insert 1 screw with U profile disc each.

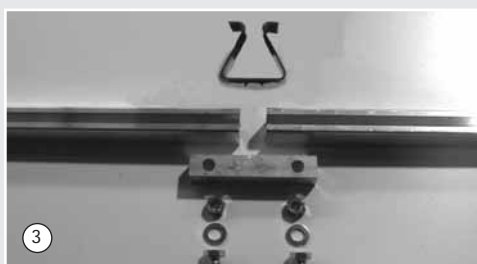

- 3./4. Afterwards insert connection of both profile rails on the side.

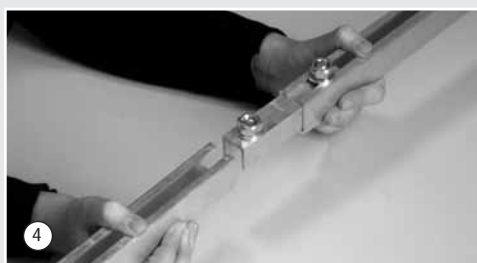

5. When connecting both profile rails push the attachment clamps in the designated grooves on the front side of the profile rails (for horizontal installation consider that the profile rails with closed long hole are used as rails below – see detail A, page 6).





# Installation instructions



6. Secure profile rails and connector with screw M 12 x 20.

## ■ Steps of installation



- 7./8./9. Only applies for horizontal installation: For better resistance install a securing (detail B, page 6) above the 2 lowest attachment anchors universal.

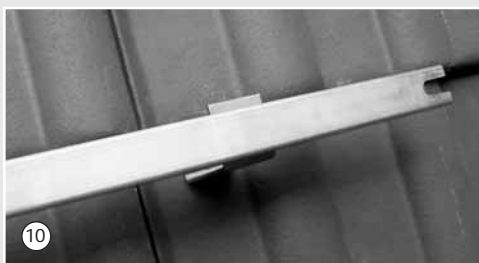

- 10./11. Profile rails with hexagonal screws M 10 x 30 and U profile washers are tightened through the long holes of the attachment anchor universal.



# Installation instructions

## ■ Steps of installation

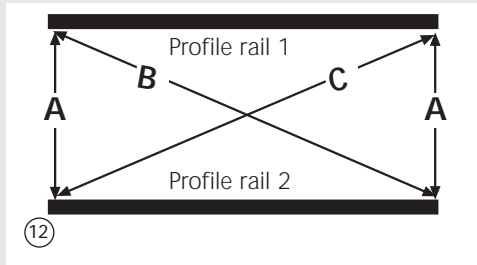

12. Define parallelism with a consistent measure A. Check the diagonal profile rails with a string and adjust differences in length if necessary. If measure  $C = B$ , the profile rails are correctly adjusted and can be tightened. Make sure that measure A does not change when adjusting. It could be useful to mark the position of the rail onto the attachment anchor universal.



13. There are slots on the back side of the collector (for vertical and horizontal installation) to apply collector to profile rails.



14. Place collector on profile rails and slide it into attachment clamps from the side.



15./16. Fix both outer attachment clamps with U profile and hexagonal screw M 10 x 25 mm. Before installing the second and any additional collector remove the protection film on the sides where the collectors touch.

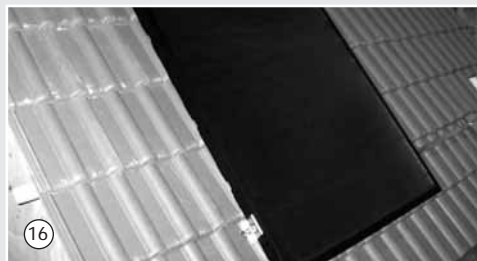

17. For installing the sensor remove the rubber sleeve, thread the sensor, place heat conducting paste on the sensor and insert as far as possible into the immersion sleeve. Afterwards push rubber sleeve behind the countering lip.

# Installation instructions



18. Secure correct position of the flat sealing when installing the corrugated hose plaid.

## ■ Steps of installation



19. When tightening the screw connections make sure to push against the collector. Non-compliance can damage the collector.



20. Prepare ventilation block (cut fence) and if necessary separate available sarking membrane and fix in raised position, respectively use sealing member (special wholesaler). Observe rising corrugated hose positioning!



# Installation instructions

## ■ Industrial safety instructions and regulations of technology

- Installation on roofs: DIN 18338 tilers and roof sealing work, DIN 18339 plumbing, DIN 18451 scaffold work.
- Connection of thermal solar installations: DIN 4757 part 1 and 3.
- Electrical connections: VDE 0100 installation of electronic equipment, VDE 0185 general information with regard to lightning protection installation, VDE 0190 main potential adjustment of electronic installations, DIN 18382 electronic cables in houses.

Detailed information referring to prevention of accidents can be found at Accident Prevention and Insurance Association.

### Use ladder appropriate

Use ladder only for a height difference up to 5 m. Lean and secure in an angle of 65-75°. Exit must be topped by a minimum of 1 m.

### Security of not falling of the roof

In case of falling height > 3m on roofs with a slope between 20° and 60°, it is required to provide corresponding security for falling protection (VBG 37, § 8). The vertical distance from the working place to the roof scaffold or alternatively the roof protection wall should not exceed 5 m. For protection it is also possible to use a safety line. Security hooks must be installed above the user on a sustainable component. Do not use ladder hooks

### Security of falling parts

Protect roads and working places below against falling or upsetting components. These areas must be marked and blocked.

# Roth

ROTH WERKE GMBH  
Am Seerain 2 • 35232 Dautphetal  
Telefon 0 64 66/9 22-0 • Telefax 0 64 66/9 22-1 00  
Hotline 0 64 66/9 22-2 66  
E-Mail: service@roth-werke.de • www.roth-werke.de



SHK ZERT

